

TAMTAKIM APARAT

CNC / UNIVERSAL
www.tamtakim.com

- Matkap Ucu Setleri
- DIN340 Taşlanmış Uzun Boy HSS Matkap Ucu
- DIN340 GT Serisi Uzun Taşlanmış Matkap Ucu
- HSS Matkap Ucu
- Precise HSS Matkap Ucu
- Fully Ground Taşlanmış Syah Altın HSS Matkap Ucu
- Sol Yönlü HSS Matkap Ucu
- Tin Kaplı Matkap Ucu
- Altın Seri Kobaltlı Matkap Ucu
- Ekstra Kalite Kobaltlı Matkap Ucu
- Karbür Matkap uçları
- Punta matkap uçları HSS/KARBÜR
- Pah/Havşa frezeleri/Pilotlu havşa (Senker)
- Kademeli matkap uçları



➤ Telefon: 0532 266 2573

e-mail: info@tamtakim.com

MATKAP UCU SETLERİ

STANDART
BOY

HSS

DIN
338



DECO Matkap Ucu Seti			
Ürün Kodu	Açıklama	Set İçeriği	Fiyat USD
D3195SET	19 Parça 1-10mm Matkap Ucu Seti	1 - 1,5 - 2 - 2,5 - 3 - 3,5 - 4 - 4,5 - 5 - 5,5 - 6 - 6,5 - 7 - 7,5 - 8 - 8,5 - 9 - 9,5 - 10	
D3120SET	25 Parça 1-13mm Matkap Ucu Seti	1 - 1,5 - 2 - 2,5 - 3 - 3,5 - 4 - 4,5 - 5 - 5,5 - 6 - 6,5 - 7 - 7,5 - 8 - 8,5 - 9 - 9,5 - 10 - 10,5 - 11 - 11,5 - 12 - 12,5 - 13	

DIN340 UZUN TAŞLANMIŞ MATKAP UCU

BEYAZ
TAŞLANMIŞ

UZUN

HSS

DIN
340

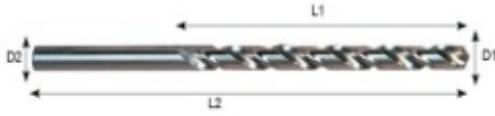

DECO DIN340 UZUN TAŞLANMIŞ MATKAP UCU

Ürün Kodu	Ölçü(ø)	Tam Boy	Kesme Boyu	Fiyat USD
D04010	1,00	56	33	
D04015	1,50	70	45	
D04020	2,00	85	56	
D04025	2,50	95	62	
D04030	3,00	100	66	
D04032	3,20	106	69	
D04033	3,30	106	69	
D04035	3,50	112	73	
D04040	4,00	119	78	
D04042	4,20	119	78	
D04045	4,50	126	82	
D04050	5,00	132	87	
D04052	5,20	134	90	
D04055	5,50	139	91	
D04060	6,00	139	91	
D04065	6,50	148	97	
D04070	7,00	156	102	
D04075	7,50	156	102	
D04080	8,00	165	109	
D04085	8,50	165	109	
D04090	9,00	175	115	
D04095	9,50	175	115	
D04100	10,00	184	121	

DECO DIN340 UZUN TAŞLANMIŞ MATKAP UCU

Ürün Kodu	Ölçü(ø)	Tam Boy	Kesme Boyu	Fiyat USD
D04105	10,50	184	121	
D04110	11,00	195	128	
D04115	11,50	195	128	
D04120	12,00	205	134	
D04125	12,50	205	134	
D04130	13,00	205	134	
D04135	13,50	214	140	
D04140	14,00	214	140	
D04145	14,50	220	144	
D04150	15,00	220	144	
D04155	15,50	227	149	
D04160	16,00	227	149	
D04165	16,50	235	154	
D04170	17,00	235	154	
D04175	17,50	241	158	
D04180	18,00	241	158	
D04185	18,50	247	162	
D04190	19,00	247	162	
D04195	19,50	254	166	
D04200	20,00	254	166	



DIN
340

DIN340 GT SERİSİ UZUN TAŞLANMIŞ MATKAP UCU

GT
SERİSİ

TAŞLANMIŞ

UZUN

DIN
340

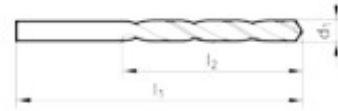

DECO DIN340 GT SERİSİ UZUN TAŞLANMIŞ MATKAP UCU				
Ürün Kodu	Ölçü(ø)	Tam Boy	Kesme Boyu	Fiyat USD
D04010GT	1,00	56	33	
D04015GT	1,50	70	45	
D04020GT	2,00	85	56	
D04025GT	2,50	95	62	
D04030GT	3,00	100	66	
D04032GT	3,20	106	69	
D04033GT	3,30	106	69	
D04035GT	3,50	112	73	
D04040GT	4,00	119	78	
D04042GT	4,20	119	78	
D04045GT	4,50	126	82	
D04050GT	5,00	132	87	
D04052GT	5,20	134	90	
D04055GT	5,50	139	91	
D04060GT	6,00	139	91	
D04065GT	6,50	148	97	
D04070GT	7,00	156	102	
D04075GT	7,50	156	102	
D04080GT	8,00	165	109	
D04085GT	8,50	165	109	
D04090GT	9,00	175	115	
D04095GT	9,50	175	115	
D04100GT	10,00	184	121	

DECO DIN340 GT SERİSİ UZUN TAŞLANMIŞ MATKAP UCU				
Ürün Kodu	Ölçü(ø)	Tam Boy	Kesme Boyu	Fiyat USD
D04105GT	10,50	184	121	
D04110GT	11,00	195	128	
D04115GT	11,50	195	128	
D04120GT	12,00	205	134	
D04125GT	12,50	205	134	
D04130GT	13,00	205	134	
D04135GT	13,50	214	140	
D04140GT	14,00	214	140	
D04145GT	14,50	220	144	
D04150GT	15,00	220	144	
D04155GT	15,50	227	149	
D04160GT	16,00	227	149	
D04165GT	16,50	235	154	
D04170GT	17,00	235	154	
D04175GT	17,50	241	158	
D04180GT	18,00	241	158	
D04185GT	18,50	247	162	
D04190GT	19,00	247	162	
D04195GT	19,50	254	166	
D04200GT	20,00	254	166	



MATKAP UCU - DIN338 - HSS



DECO DIN338 MATKAP UCU - HSS				
Ürün Kodu	Matkap Çapı (ø)	Tam Boy (mm)	Kesme Boyu (mm)	Fiyat USD
DU3010	1,00	34	12	
DU3011	1,10	36	14	
DU3012	1,20	38	16	
DU3013	1,30	38	16	
DU3014	1,40	40	18	
DU3015	1,50	40	18	
DU3016	1,60	43	20	
DU3017	1,70	43	20	
DU3018	1,80	46	22	
DU3019	1,90	46	22	
DU3020	2,00	49	24	
DU3021	2,10	49	24	
DU3022	2,20	53	27	
DU3023	2,30	53	27	
DU3024	2,40	57	30	
DU3025	2,50	57	30	
DU3026	2,60	57	30	
DU3027	2,70	61	33	
DU3028	2,80	61	33	
DU3029	2,90	61	33	
DU3030	3,00	61	33	
DU3031	3,10	65	36	
DU3032	3,20	65	36	
DU3033	3,30	65	36	
DU3034	3,40	70	39	
DU3035	3,50	70	39	
DU3036	3,60	70	39	
DU3037	3,70	70	39	
DU3038	3,80	75	43	
DU3039	3,90	75	43	
DU3040	4,00	75	43	
DU3041	4,10	75	43	
DU3042	4,20	75	43	
DU3043	4,30	80	47	
DU3044	4,40	80	47	
DU3045	4,50	80	47	
DU3046	4,60	80	47	
DU3047	4,70	80	47	
DU3048	4,80	86	52	
DU3049	4,90	86	52	
DU3050	5,00	86	52	
DU3051	5,10	86	52	
DU3052	5,20	86	52	
DU3053	5,30	86	52	
DU3054	5,40	93	57	

DECO DIN338 MATKAP UCU - HSS				
Ürün Kodu	Matkap Çapı (ø)	Tam Boy (mm)	Kesme Boyu (mm)	Fiyat USD
DU3055	5,50	93	57	
DU3056	5,60	93	57	
DU3057	5,70	93	57	
DU3058	5,80	93	57	
DU3059	5,90	93	57	
DU3060	6,00	93	57	
DU3061	6,10	101	63	
DU3062	6,20	101	63	
DU3063	6,30	101	63	
DU3064	6,40	101	63	
DU3065	6,50	101	63	
DU3066	6,60	101	63	
DU3067	6,70	101	63	
DU3068	6,80	109	69	
DU3069	6,90	109	69	
DU3070	7,00	109	69	
DU3071	7,10	109	69	
DU3072	7,20	109	69	
DU3073	7,30	109	69	
DU3074	7,40	109	69	
DU3075	7,50	109	69	
DU3076	7,60	117	75	
DU3077	7,70	117	75	
DU3078	7,80	117	75	
DU3079	7,90	117	75	
DU3080	8,00	117	75	
DU3081	8,10	117	75	
DU3082	8,20	117	75	
DU3083	8,30	117	75	
DU3084	8,40	117	75	
DU3085	8,50	117	75	
DU3086	8,60	125	81	
DU3087	8,70	125	81	
DU3088	8,80	125	81	
DU3089	8,90	125	81	
DU3090	9,00	125	81	
DU3091	9,10	125	81	
DU3092	9,20	125	81	
DU3093	9,30	125	81	
DU3094	9,40	125	81	
DU3095	9,50	125	81	
DU3096	9,60	133	87	
DU3097	9,70	133	87	
DU3098	9,80	133	87	
DU3099	9,90	133	87	

MATKAP UCU - DIN338 - HSS



DECO DIN338 MATKAP UCU - HSS				
Ürün Kodu	Matkap Çapı (ø)	Tam Boy (mm)	Kesme Boyu (mm)	Fiyat USD
DU3100	10,00	133	87	
DU3101	10,10	133	87	
DU3102	10,20	133	87	
DU3103	10,30	133	87	
DU3104	10,40	133	87	
DU3105	10,50	133	94	
DU3106	10,60	133	94	
DU3107	10,70	142	94	
DU3108	10,80	142	94	
DU3109	10,90	142	94	
DU3110	11,00	142	94	
DU3111	11,10	142	94	
DU3112	11,20	142	94	
DU3113	11,30	142	94	
DU3114	11,40	142	94	
DU3115	11,50	142	94	
DU3116	11,60	142	94	
DU3117	11,70	142	94	
DU3118	11,80	142	94	
DU3119	11,90	151	101	
DU3120	12,00	151	101	
DU3121	12,10	151	101	
DU3122	12,20	151	101	
DU3123	12,30	151	101	
DU3124	12,40	151	101	
DU3125	12,50	151	101	
DU3126	12,60	151	101	
DU3127	12,70	151	101	
DU3128	12,80	151	101	
DU3129	12,90	151	101	
DU3130	13,00	151	101	
DU3131	13,10	151	101	
DU3132	13,20	151	101	
DU3133	13,30	160	108	
DU3134	13,40	160	108	
DU3135	13,50	160	108	
DU3136	13,60	160	108	
DU3137	13,70	160	108	
DU3138	13,80	160	108	
DU3139	13,90	160	108	
DU3140	14,00	160	108	
DU3141	14,10	169	114	
DU3142	14,20	169	114	
DU3143	14,30	169	114	
DU3144	14,40	169	114	

DECO DIN338 MATKAP UCU - HSS				
Ürün Kodu	Matkap Çapı (ø)	Tam Boy (mm)	Kesme Boyu (mm)	Fiyat USD
DU3145	14,50	169	114	
DU3146	14,60	169	114	
DU3147	14,70	169	114	
DU3148	14,80	169	114	
DU3149	14,90	169	114	
DU3150	15,00	169	114	
DU3151	15,10	169	120	
DU3152	15,20	178	120	
DU3153	15,30	178	120	
DU3154	15,40	178	120	
DU3155	15,50	178	120	
DU3156	15,60	178	120	
DU3157	15,70	178	120	
DU3158	15,80	178	120	
DU3159	15,90	178	120	
DU3160	16,00	178	120	
DU3161	16,10	178	120	
DU3162	16,20	178	120	
DU3163	16,30	178	120	
DU3164	16,40	178	120	
DU3165	16,50	184	125	
DU3166	16,60	184	125	
DU3167	16,70	184	125	
DU3168	16,80	184	125	
DU3169	16,90	184	125	
DU3170	17,00	184	125	
DU3175	17,50	191	130	
DU3180	18,00	191	130	
DU3185	18,50	198	135	
DU3190	19,00	198	135	
DU3195	19,50	205	140	
DU3200	20,00	205	140	
DU3205	20,50	205	145	
DU3210	21,00	205	145	
DU3215	21,50	210	150	
DU3220	22,00	210	150	
DU3225	22,50	215	155	
DU3230	23,00	215	155	
DU3235	23,50	220	160	
DU3240	24,00	220	160	
DU3245	24,50	220	160	
DU3250	25,00	220	160	

PRECISE MODEL MATKAP UCU - DIN338

EKSTRA KALİTE - PRECİSE MODEL



STANDART
BOY

HSS

DIN
338

DECO DIN338 MATKAP UCU PRECİSE MODEL				
Ürün Kodu	Matkap Çapı (ø)	Kesme Boyu (mm)	Tam Boyu (mm)	Fiyat USD
D3010	1,00	12	34	
D3011	1,10	14	36	
D3012	1,20	16	38	
D3013	1,30	16	38	
D3014	1,40	18	40	
D3015	1,50	18	40	
D3016	1,60	20	43	
D3017	1,70	20	43	
D3018	1,80	22	46	
D3019	1,90	22	46	
D3020	2,00	24	49	
D3021	2,10	24	49	
D3022	2,20	27	53	
D3023	2,30	27	53	
D3024	2,40	30	57	
D3025	2,50	30	57	
D3026	2,60	30	57	
D3027	2,70	33	61	
D3028	2,80	33	61	
D3029	2,90	33	61	
D3030	3,00	33	61	
D3031	3,10	36	65	
D3032	3,20	36	65	
D3033	3,30	36	65	
D3034	3,40	39	70	
D3035	3,50	39	70	
D3036	3,60	39	70	
D3037	3,70	39	70	
D3038	3,80	43	75	
D3039	3,90	43	75	
D3040	4,00	43	75	
D3041	4,10	43	75	
D3042	4,20	43	75	
D3043	4,30	47	80	
D3044	4,40	47	80	
D3045	4,50	47	80	
D3046	4,60	47	80	
D3047	4,70	47	80	
D3048	4,80	52	86	
D3049	4,90	52	86	
D3050	5,00	52	86	
D3051	5,10	52	86	
D3052	5,20	52	86	
D3053	5,30	52	86	
D3054	5,40	57	93	

DECO DIN338 MATKAP UCU PRECİSE MODEL				
Ürün Kodu	Matkap Çapı (ø)	Kesme Boyu (mm)	Tam Boyu (mm)	Fiyat USD
D3055	5,50	57	93	
D3056	5,60	57	93	
D3057	5,70	57	93	
D3058	5,80	57	93	
D3059	5,90	57	93	
D3060	6,00	57	93	
D3061	6,10	63	101	
D3062	6,20	63	101	
D3063	6,30	63	101	
D3064	6,40	63	101	
D3065	6,50	63	101	
D3066	6,60	63	101	
D3067	6,70	63	101	
D3068	6,80	69	109	
D3069	6,90	69	109	
D3070	7,00	69	109	
D3071	7,10	69	109	
D3072	7,20	69	109	
D3073	7,30	69	109	
D3074	7,40	69	109	
D3075	7,50	69	109	
D3076	7,60	75	117	
D3077	7,70	75	117	
D3078	7,80	75	117	
D3079	7,90	75	117	
D3080	8,00	75	117	
D3081	8,10	75	117	
D3082	8,20	75	117	
D3083	8,30	75	117	
D3084	8,40	75	117	
D3085	8,50	75	117	
D3086	8,60	81	125	
D3087	8,70	81	125	
D3088	8,80	81	125	
D3089	8,90	81	125	
D3090	9,00	81	125	
D3091	9,10	81	125	
D3092	9,20	81	125	
D3093	9,30	81	125	
D3094	9,40	81	125	
D3095	9,50	81	125	
D3096	9,60	87	133	
D3097	9,70	87	133	
D3098	9,80	87	133	
D3099	9,90	87	133	

PRECISE MODEL MATKAP UCU - DIN338

EKSTRA KALİTE - PRECİSE MODEL



STANDART
BOY

HSS

DIN
338

DECO DIN338 MATKAP UCU PRECİSE MODEL				
Ürün Kodu	Matkap Çapı (ø)	Kesme Boyu (mm)	Tam Boyu (mm)	Fiyat USD
D3100	10,00	87	133	
D3101	10,10	87	133	
D3102	10,20	87	133	
D3103	10,30	87	133	
D3104	10,40	87	133	
D3105	10,50	94	133	
D3106	10,60	94	133	
D3107	10,70	94	142	
D3108	10,80	94	142	
D3109	10,90	94	142	
D3110	11,00	94	142	
D3111	11,10	94	142	
D3112	11,20	94	142	
D3113	11,30	94	142	
D3114	11,40	94	142	
D3115	11,50	94	142	
D3116	11,60	94	142	
D3117	11,70	94	142	
D3118	11,80	94	142	
D3119	11,90	101	151	
D3120	12,00	101	151	
D3121	12,10	101	151	
D3122	12,20	101	151	
D3123	12,30	101	151	
D3124	12,40	101	151	
D3125	12,50	101	151	
D3126	12,60	101	151	
D3127	12,70	101	151	
D3128	12,80	101	151	
D3129	12,90	101	151	
D3130	13,00	101	151	
D3131	13,10	101	151	
D3132	13,20	101	151	
D3133	13,30	108	160	
D3134	13,40	108	160	
D3135	13,50	108	160	
D3136	13,60	108	160	
D3137	13,70	108	160	
D3138	13,80	108	160	
D3139	13,90	108	160	
D3140	14,00	108	160	
D3141	14,10	114	169	
D3142	14,20	114	169	
D3143	14,30	114	169	
D3144	14,40	114	169	

DECO DIN338 MATKAP UCU PRECİSE MODEL				
Ürün Kodu	Matkap Çapı (ø)	Kesme Boyu (mm)	Tam Boyu (mm)	Fiyat USD
D3145	14,50	114	169	
D3146	14,60	114	169	
D3147	14,70	114	169	
D3148	14,80	114	169	
D3149	14,90	114	169	
D3150	15,00	114	169	
D3151	15,10	120	178	
D3152	15,20	120	178	
D3153	15,30	120	178	
D3154	15,40	120	178	
D3155	15,50	120	178	
D3156	15,60	120	178	
D3157	15,70	120	178	
D3158	15,80	120	178	
D3159	15,90	120	178	
D3160	16,00	120	178	
D3161	16,10	125	184	
D3162	16,20	125	184	
D3163	16,30	125	184	
D3164	16,40	125	184	
D3165	16,50	125	184	
D3166	16,60	125	184	
D3167	16,70	125	184	
D3168	16,80	125	184	
D3169	16,90	125	184	
D3170	17,00	125	184	
D3175	17,50	130	191	
D3180	18,00	130	191	
D3185	18,50	135	198	
D3190	19,00	135	198	
D3195	19,50	140	205	
D3200	20,00	140	205	
D32051	20,50	145	213	
D32052	21,00	145	213	
D32053	21,50	150	221	
D32054	22,00	150	221	
D32055	22,50	155	229	
D32056	23,00	155	229	
D320565	23,50	155	229	
D32057	24,00	160	236	
D320575	24,50	160	236	
D32058	25,00	160	236	
D32059	25,50	160	236	
D32060	26,00	160	236	

TAM TAKIM APARAT MAKİNA
SAN. VE TİC. LTD. ŞTİ.
www.tamtakim.com

FULLY GROUND TAŞLANMIŞ SİYAH ALTIN MATKAP UCU



DECO FULLY GROUND TAŞLANMIŞ SİYAH ALTIN MATKAP UCU				
Ürün Kodu	Matkap Çapı (ø)	Kesme Boyu (mm)	Tam Boyu (mm)	Fiyat USD
D310100	1,00	12	34	
D310110	1,10	14	36	
D310120	1,20	16	38	
D310130	1,30	16	38	
D310140	1,40	18	40	
D310150	1,50	18	40	
D310160	1,60	20	43	
D310170	1,70	20	43	
D310180	1,80	22	46	
D310190	1,90	22	46	
D310200	2,00	24	49	
D310210	2,10	24	49	
D310220	2,20	27	53	
D310230	2,30	27	53	
D310240	2,40	30	57	
D310250	2,50	30	57	
D310260	2,60	30	57	
D310270	2,70	33	61	
D310280	2,80	33	61	
D310290	2,90	33	61	
D310300	3,00	33	61	
D310310	3,10	36	65	
D310320	3,20	36	65	
D310330	3,30	36	65	
D310340	3,40	39	70	
D310350	3,50	39	70	
D310360	3,60	39	70	
D310370	3,70	39	70	
D310380	3,80	43	75	
D310390	3,90	43	75	
D310400	4,00	43	75	
D310410	4,10	43	75	
D310420	4,20	43	75	
D310430	4,30	47	80	
D310440	4,40	47	80	
D310450	4,50	47	80	
D310460	4,60	47	80	
D310470	4,70	47	80	
D310480	4,80	52	86	
D310490	4,90	52	86	
D310500	5,00	52	86	
D310510	5,10	52	86	
D310520	5,20	52	86	
D310530	5,30	52	86	
D310540	5,40	57	93	

DECO FULLY GROUND TAŞLANMIŞ SİYAH ALTIN MATKAP UCU				
Ürün Kodu	Matkap Çapı (ø)	Kesme Boyu (mm)	Tam Boyu (mm)	Fiyat USD
D310550	5,50	57	93	
D310560	5,60	57	93	
D310570	5,70	57	93	
D310580	5,80	57	93	
D310590	5,90	57	93	
D310600	6,00	57	93	
D310610	6,10	63	101	
D310620	6,20	63	101	
D310630	6,30	63	101	
D310640	6,40	63	101	
D310650	6,50	63	101	
D310660	6,60	63	101	
D310670	6,70	63	101	
D310680	6,80	69	109	
D310690	6,90	69	109	
D310700	7,00	69	109	
D310710	7,10	69	109	
D310720	7,20	69	109	
D310730	7,30	69	109	
D310740	7,40	69	109	
D310750	7,50	69	109	
D310760	7,60	75	117	
D310770	7,70	75	117	
D310780	7,80	75	117	
D310790	7,90	75	117	
D310800	8,00	75	117	
D310810	8,10	75	117	
D310820	8,20	75	117	
D310830	8,30	75	117	
D310840	8,40	75	117	
D310850	8,50	75	117	
D310860	8,60	81	125	
D310870	8,70	81	125	
D310880	8,80	81	125	
D310890	8,90	81	125	
D310900	9,00	81	125	
D310910	9,10	81	125	
D310920	9,20	81	125	
D310930	9,30	81	125	
D310940	9,40	81	125	
D310950	9,50	81	125	
D310960	9,60	87	133	
D310970	9,70	87	133	
D310980	9,80	87	133	
D310990	9,90	87	133	

FULLY GROUND TAŞLANMIŞ SİYAH ALTIN MATKAP UCU



DECO FULLY GROUND TAŞLANMIŞ SİYAH ALTIN MATKAP UCU				
Ürün Kodu	Matkap Çapı (ø)	Kesme Boyu (mm)	Tam Boyu (mm)	Fiyat USD
D311000	10,00	87	133	
D311010	10,10	87	133	
D311020	10,20	87	133	
D311030	10,30	87	133	
D311040	10,40	87	133	
D311050	10,50	94	133	
D311060	10,60	94	133	
D311070	10,70	94	142	
D311080	10,80	94	142	
D311090	10,90	94	142	
D311100	11,00	94	142	
D311110	11,10	94	142	
D311120	11,20	94	142	
D311130	11,30	94	142	
D311140	11,40	94	142	
D311150	11,50	94	142	
D311160	11,60	94	142	
D311170	11,70	94	142	
D311180	11,80	94	142	
D311190	11,90	101	151	
D311200	12,00	101	151	
D311210	12,10	101	151	
D311220	12,20	101	151	
D311230	12,30	101	151	
D311240	12,40	101	151	
D311250	12,50	101	151	
D311260	12,60	101	151	
D311270	12,70	101	151	
D311280	12,80	101	151	
D311290	12,90	101	151	
D311300	13,00	101	151	
D311310	13,10	101	151	
D311320	13,20	101	151	
D311330	13,30	108	160	
D311340	13,40	108	160	
D311350	13,50	108	160	
D311360	13,60	108	160	
D311370	13,70	108	160	
D311380	13,80	108	160	
D311390	13,90	108	160	
D311400	14,00	108	160	
D311410	14,10	114	169	
D311420	14,20	114	169	
D311430	14,30	114	169	
D311440	14,40	114	169	

DECO FULLY GROUND TAŞLANMIŞ SİYAH ALTIN MATKAP UCU				
Ürün Kodu	Matkap Çapı (ø)	Kesme Boyu (mm)	Tam Boyu (mm)	Fiyat USD
D311450	14,50	114	169	
D311460	14,60	114	169	
D311470	14,70	114	169	
D311480	14,80	114	169	
D311490	14,90	114	169	
D311500	15,00	114	169	
D311510	15,10	120	178	
D311520	15,20	120	178	
D311530	15,30	120	178	
D311540	15,40	120	178	
D311550	15,50	120	178	
D311560	15,60	120	178	
D311570	15,70	120	178	
D311580	15,80	120	178	
D311590	15,90	120	178	
D311600	16,00	120	178	
D311610	16,10	125	184	
D311620	16,20	125	184	
D311630	16,30	125	184	
D311640	16,40	125	184	
D311650	16,50	125	184	
D311660	16,60	125	184	
D311670	16,70	125	184	
D311680	16,80	125	184	
D311690	16,90	125	184	
D311700	17,00	125	184	
D311750	17,50	130	191	
D311800	18,00	130	191	
D311850	18,50	135	198	
D311900	19,00	135	198	
D311950	19,50	140	205	
D312000	20,00	140	205	
D312050	20,50	145	213	
D312100	21,00	145	213	
D312150	21,50	150	221	
D312200	22,00	150	221	
D312250	22,50	155	229	
D312300	23,00	155	229	
D312350	23,50	155	229	
D312400	24,00	160	236	
D312450	24,50	160	236	
D312500	25,00	160	236	
D312550	25,50	160	236	
D312600	26,00	160	236	

SOL MATKAP UCU - DIN338 SOL



DECO SOL Matkap Ucu - DIN338				
Ürün Kodu	Ölçü(ø)	Tam Boy	Kesme Boyu	Fiyat USD
D3010-SOL	1,0 mm	12	34	
D3012-SOL	1,2 mm	16	38	
D3015-SOL	1,5 mm	18	40	
D3020-SOL	2,0 mm	24	49	
D3025-SOL	2,5 mm	30	57	
D3030-SOL	3,0 mm	33	61	
D3031-SOL	3,1 mm	36	65	
D3032-SOL	3,2 mm	36	65	
D3033-SOL	3,3 mm	36	65	
D3035-SOL	3,5 mm	39	70	
D3040-SOL	4,0 mm	43	75	
D3042-SOL	4,2 mm	43	75	
D3043-SOL	4,3 mm	43	80	
D3045-SOL	4,5 mm	47	80	
D3050-SOL	5,0 mm	52	86	
D3052-SOL	5,2 mm	52	86	
D3055-SOL	5,5 mm	57	93	
D3060-SOL	6,0 mm	57	93	
D3062-SOL	6,2 mm	63	101	
D3065-SOL	6,5 mm	63	101	
D3067-SOL	6,7 mm	63	101	
D3068-SOL	6,8 mm	69	109	
D3070-SOL	7,0 mm	69	109	
D3075-SOL	7,5 mm	69	117	
D3080-SOL	8,0 mm	75	117	
D3085-SOL	8,5 mm	75	117	
D3090-SOL	9,0 mm	81	125	
D3095-SOL	9,5 mm	87	133	
D3100-SOL	10,0 mm	87	133	
D3105-SOL	10,5 mm	87	133	
D3110-SOL	11,0 mm	94	142	
D3115-SOL	11,5 mm	101	151	
D3120-SOL	12,0 mm	101	151	
D3125-SOL	12,5 mm	101	151	
D3130-SOL	13,0 mm	101	151	



SOL YÖNLÜ

TİN KAPLI MATKAP UCU - DIN338



TİN
KAPLI

DIN
338

DECO - DIN338 TİN KAPLI MATKAP UCU

Ürün Kodu	Ölçü(ø)	Tam Boyu	Kesici Boyu	Fiyat USD
D300100	1 mm	12	34	
D300150	1,5 mm	18	40	
D300200	2 mm	24	49	
D300220	2,2 mm	27	53	
D300250	2,5 mm	30	57	
D300300	3 mm	33	61	
D300320	3,2 mm	36	65	
D300330	3,3 mm	36	65	
D300350	3,5 mm	39	70	
D300400	4 mm	43	75	
D300420	4,2 mm	43	75	
D300450	4,5 mm	47	80	
D300500	5 mm	52	86	
D300520	5,2 mm	52	86	
D300550	5,5 mm	57	93	
D300600	6 mm	57	93	
D300650	6,5 mm	63	101	
D300670	6,7 mm	63	101	
D300680	6,8 mm	63	101	
D300700	7 mm	69	109	
D300800	8 mm	75	117	
D300850	8,5 mm	75	117	
D300900	9 mm	81	125	
D301000	10 mm	81	133	
D301500	10,5 mm	87	133	
D301100	11 mm	94	142	
D301150	11,5 mm	94	142	
D301200	12 mm	101	151	
D301250	12,5 mm	101	151	
D301300	13 mm	101	101	
D301350	13,5 mm	108	160	
D301400	14 mm	108	160	
D301450	14,5 mm	114	169	
D301500	15 mm	120	169	
D301550	15,5 mm	120	178	
D301600	16 mm	178	178	
D301650	16,5 mm	184	184	
D301700	17 mm	125	184	
D301750	17,5 mm	130	191	
D301800	18 mm	130	191	
D301850	18,5 mm	135	198	
D301900	19 mm	138	198	
D301950	19,5 mm	140	205	
D302000	20 mm	140	205	



DIN338 ALTIN SERİ KOBALTLI MATKAP UCU



DECO ALTIN SERİ KOBALTLI MATKAP UCU				
Ürün Kodu	Matkap Çapı (ø)	Tam Boy (mm)	Kesme Boyu (mm)	Fiyat USD
D20010	1,00	34	12	
D20011	1,10	36	14	
D20012	1,20	38	16	
D20013	1,30	38	16	
D20014	1,40	40	18	
D20015	1,50	40	18	
D20016	1,60	43	20	
D20017	1,70	43	20	
D20018	1,80	46	22	
D20019	1,90	46	22	
D20020	2,00	49	24	
D20021	2,10	49	24	
D20022	2,20	53	27	
D20023	2,30	53	27	
D20024	2,40	57	30	
D20025	2,50	57	30	
D20026	2,60	57	30	
D20027	2,70	61	33	
D20028	2,80	61	33	
D20029	2,90	61	33	
D20030	3,00	61	33	
D20031	3,10	65	36	
D20032	3,20	65	36	
D20033	3,30	65	36	
D20034	3,40	70	39	
D20035	3,50	70	39	
D20036	3,60	70	39	
D20037	3,70	70	39	
D20038	3,80	75	43	
D20039	3,90	75	43	
D20040	4,00	75	43	
D20041	4,10	75	43	
D20042	4,20	75	43	
D20043	4,30	80	47	
D20044	4,40	80	47	
D20045	4,50	80	47	
D20046	4,60	80	47	
D20047	4,70	80	47	
D20048	4,80	86	52	
D20049	4,90	86	52	
D20050	5,00	86	52	
D20051	5,10	86	52	
D20052	5,20	86	52	
D20053	5,30	86	52	
D20054	5,40	93	57	

DECO ALTIN SERİ KOBALTLI MATKAP UCU				
Ürün Kodu	Matkap Çapı (ø)	Tam Boy (mm)	Kesme Boyu (mm)	Fiyat USD
D20055	5,50	93	57	
D20056	5,60	93	57	
D20057	5,70	93	57	
D20058	5,80	93	57	
D20059	5,90	93	57	
D20060	6,00	93	57	
D20061	6,10	101	63	
D20062	6,20	101	63	
D20063	6,30	101	63	
D20064	6,40	101	63	
D20065	6,50	101	63	
D20066	6,60	101	63	
D20067	6,70	101	63	
D20068	6,80	109	69	
D20069	6,90	109	69	
D20070	7,00	109	69	
D20071	7,10	109	69	
D20072	7,20	109	69	
D20073	7,30	109	69	
D20074	7,40	109	69	
D20075	7,50	109	69	
D20076	7,60	117	75	
D20077	7,70	117	75	
D20078	7,80	117	75	
D20079	7,90	117	75	
D20080	8,00	117	75	
D20081	8,10	117	75	
D20082	8,20	117	75	
D20083	8,30	117	75	
D20084	8,40	117	75	
D20085	8,50	117	75	
D20086	8,60	125	81	
D20087	8,70	125	81	
D20088	8,80	125	81	
D20089	8,90	125	81	
D20090	9,00	125	81	
D20091	9,10	125	81	
D20092	9,20	125	81	
D20093	9,30	125	81	
D20094	9,40	125	81	
D20095	9,50	125	81	
D20096	9,60	133	87	
D20097	9,70	133	87	
D20098	9,80	133	87	
D20099	9,90	133	87	

DIN338 ALTIN SERİ KOBALTLI MATKAP UCU



DECO ALTIN SERİ KOBALTLI MATKAP UCU

Ürün Kodu	Matkap Çapı (ø)	Tam Boy (mm)	Kesme Boyu (mm)	Fiyat USD
D20100	10,00	133	87	
D20101	10,10	133	87	
D20102	10,20	133	87	
D20103	10,30	133	87	
D20104	10,40	133	87	
D20105	10,50	133	94	
D20106	10,60	133	94	
D20107	10,70	142	94	
D20108	10,80	142	94	
D20109	10,90	142	94	
D20110	11,00	142	94	
D20111	11,10	142	94	
D20112	11,20	142	94	
D20113	11,30	142	94	
D20114	11,40	142	94	
D20115	11,50	142	94	
D20116	11,60	142	94	
D20117	11,70	142	94	
D20118	11,80	142	94	
D20119	11,90	151	101	
D20120	12,00	151	101	
D20121	12,10	151	101	
D20122	12,20	151	101	
D20123	12,30	151	101	
D20124	12,40	151	101	
D20125	12,50	151	101	
D20126	12,60	151	101	
D20127	12,70	151	101	
D20128	12,80	151	101	
D20129	12,90	151	101	
D20130	13,00	151	101	
D20131	13,10	151	101	
D20132	13,20	151	101	
D20133	13,30	160	108	
D20134	13,40	160	108	
D20135	13,50	160	108	
D20136	13,60	160	108	
D20137	13,70	160	108	
D20138	13,80	160	108	
D20139	13,90	160	108	
D20140	14,00	160	108	
D20141	14,10	169	114	
D20142	14,20	169	114	
D20143	14,30	169	114	
D20144	14,40	169	114	

DECO ALTIN SERİ KOBALTLI MATKAP UCU

Ürün Kodu	Matkap Çapı (ø)	Tam Boy (mm)	Kesme Boyu (mm)	Fiyat USD
D20145	14,50	169	114	
D20146	14,60	169	114	
D20147	14,70	169	114	
D20148	14,80	169	114	
D20149	14,90	169	114	
D20150	15,00	169	114	
D20151	15,10	169	120	
D20152	15,20	178	120	
D20153	15,30	178	120	
D20154	15,40	178	120	
D20155	15,50	178	120	
D20156	15,60	178	120	
D20157	15,70	178	120	
D20158	15,80	178	120	
D20159	15,90	178	120	
D20160	16,00	178	120	
D20165	16,50	184	125	
D20170	17,00	184	125	
D20175	17,50	191	130	
D20180	18,00	191	130	
D20185	18,50	198	135	
D20190	19,00	198	135	
D20195	19,50	205	140	
D20200	20,00	205	140	

KUYUMCU VE SAATÇİ MATKAP UCU



ÜRÜN KODU	AÇIKLAMA	FIYAT USD
E1455025	0,25 MM MATKAP UCU HSS	-
E1455030	0,30 MM MATKAP UCU HSS	-
E1455035	0,35 MM MATKAP UCU HSS	-
E1455040	0,40 MM MATKAP UCU HSS	-
E1455055	0,55 MM MATKAP UCU HSS	-
E1455070	0,70 MM MATKAP UCU HSS	-
E1455085	0,85 MM MATKAP UCU HSS	-

MATKAP UCU - DIN338



STANDART
BOY

SİYAH
BEYAZ
HSS

DIN
338

ERT DIN338 MATKAP UCU - HSS					ERT DIN338 MATKAP UCU - HSS				
Ürün Kodu	Matkap Çapı (ø)	Kesme Boyu (mm)	Tam Boyu (mm)	Fiyat USD	Ürün Kodu	Matkap Çapı (ø)	Kesme Boyu (mm)	Tam Boyu (mm)	Fiyat USD
E45005	0,50	6	22		E45046	4,60	47	80	
E45006	0,60	7	24		E45047	4,70	47	80	
E45007	0,70	9	28		E45048	4,80	52	86	
E45008	0,80	10	30		E45049	4,90	52	86	
E45009	0,90	11	32		E45050	5,00	52	86	
E45010	1,00	12	34		E45051	5,10	52	86	
E45011	1,10	14	36		E45052	5,20	52	86	
E45012	1,20	16	38		E45053	5,30	52	86	
E45013	1,30	16	38		E45054	5,40	57	93	
E45014	1,40	18	40		E45055	5,50	57	93	
E45015	1,50	18	40		E45056	5,60	57	93	
E45016	1,60	20	43		E45057	5,70	57	93	
E45017	1,70	20	43		E45058	5,80	57	93	
E45018	1,80	22	46		E45059	5,90	57	93	
E45019	1,90	22	46		E45060	6,00	57	93	
E45020	2,00	24	49		E45061	6,10	63	101	
E45021	2,10	24	49		E45062	6,20	63	101	
E45022	2,20	27	53		E45063	6,30	63	101	
E45023	2,30	27	53		E45064	6,40	63	101	
E45024	2,40	30	57		E45065	6,50	63	101	
E45025	2,50	30	57		E45066	6,60	63	101	
E45026	2,60	30	57		E45067	6,70	63	101	
E45027	2,70	33	61		E45068	6,80	69	109	
E45028	2,80	33	61		E45069	6,90	69	109	
E45029	2,90	33	61		E45070	7,00	69	109	
E45030	3,00	33	61		E45071	7,10	69	109	
E45031	3,10	36	65		E45072	7,20	69	109	
E45032	3,20	36	65		E45073	7,30	69	109	
E45033	3,30	36	65		E45074	7,40	69	109	
E45034	3,40	39	70		E45075	7,50	69	109	
E45035	3,50	39	70		E45076	7,60	75	117	
E45036	3,60	39	70		E45077	7,70	75	117	
E45037	3,70	39	70		E45078	7,80	75	117	
E45038	3,80	43	75		E45079	7,90	75	117	
E45039	3,90	43	75		E45080	8,00	75	117	
E45040	4,00	43	75		E45081	8,10	75	117	
E45041	4,10	43	75		E45082	8,20	75	117	
E45042	4,20	43	75		E45083	8,30	75	117	
E45043	4,30	47	80		E45084	8,40	75	117	
E45044	4,40	47	80		E45085	8,50	75	117	
E45045	4,50	47	80						

MATKAP UCU - DIN338



ERT DIN338 MATKAP UCU - HSS					ERT DIN338 MATKAP UCU - HSS				
Ürün Kodu	Matkap Çapı (ø)	Kesme Boyu (mm)	Tam Boyu (mm)	Fiyat USD	Ürün Kodu	Matkap Çapı (ø)	Kesme Boyu (mm)	Tam Boyu (mm)	Fiyat USD
E45086	8,60	81	125		E45126	12,60	101	151	
E45087	8,70	81	125		E45127	12,70	101	151	
E45088	8,80	81	125		E45128	12,80	101	151	
E45089	8,90	81	125		E45129	12,90	101	151	
E45090	9,00	81	125		E45130	13,00	101	151	
E45091	9,10	81	125		E45131	13,10	101	151	
E45092	9,20	81	125		E45132	13,20	101	151	
E45093	9,30	81	125		E45133	13,30	108	160	
E45094	9,40	81	125		E45134	13,40	108	160	
E45095	9,50	81	125		E45135	13,50	108	160	
E45096	9,60	87	133		E45136	13,60	108	160	
E45097	9,70	87	133		E45137	13,70	108	160	
E45098	9,80	87	133		E45138	13,80	108	160	
E45099	9,90	87	133		E45139	13,90	108	160	
E45100	10,00	87	133		E45140	14,00	108	160	
E45101	10,10	87	133		E45142	14,20	114	169	
E45102	10,20	87	133		E45145	14,50	114	169	
E45103	10,30	87	133		E45146	14,80	114	169	
E45104	10,40	87	133		E45148	14,90	114	169	
E45105	10,50	87	133		E45150	15,00	114	169	
E14106	10,60	87	133		E45152	15,20	120	178	
E45107	10,70	94	142		E45155	15,50	120	178	
E45108	10,80	94	142		E45158	15,80	120	178	
E45109	10,90	94	142		E45160	16,00	120	178	
E45110	11,00	94	142		E45162	16,20	125	184	
E45111	11,10	94	142		E45165	16,50	125	184	
E45112	11,20	94	142		E45170	17,00	125	184	
E45113	11,30	94	142		E45175	17,50	130	191	
E45114	11,40	94	142		E45180	18,00	130	191	
E45115	11,50	94	142		E45185	18,50	135	198	
E45116	11,60	94	142		E45190	19,00	135	198	
E45117	11,70	94	142		E45195	19,50	140	205	
E45118	11,80	94	142		E45200	20,00	140	205	
E45119	11,90	101	151		E45205	20,50	145	213	
E45120	12,00	101	151		E45210	21,00	145	213	
E45121	12,10	101	151		E45215	21,50	150	221	
E45122	12,20	101	151		E45220	22,00	150	221	
E45123	12,30	101	151		E45225	22,50	155	229	
E45124	12,40	101	151		E45230	23,00	155	229	
E45125	12,50	101	151		E45235	23,50	155	229	
					E45240	24,00	160	236	
					E45245	24,50	160	236	
					E45250	25,00	160	236	

KARBÜR MATKAP UCU – DIN/1897

EKSTRA KALİTE KARBÜR MATKAP UCU

DIN 1897 KISA BOY



DECO KARBÜR MATKAP UCU - KISA TİP

ÜRÜN KODU	ÖLÇÜ MM	KESİCİ BOY MM	TAM BOY MM	FİYAT USD
D06020	2,0	12	40	
D06025	2,5	14	43	
D06030	3,0	16	46	
D06032	3,2	16	46	
D06033	3,3	16	46	
D06035	3,5	20	52	
D06040	4,0	22	55	
D06042	4,2	22	55	
D06045	4,5	24	58	
D06050	5,0	26	62	
D06052	5,2	26	63	
D06055	5,5	28	66	
D06060	6,0	28	66	
D06062	6,2	31	70	
D06065	6,5	31	70	
D06067	6,7	31	70	
D06068	6,8	31	70	
D06068	7,0	34	74	
D06075	7,5	34	74	
D06080	8,0	37	79	
D06085	8,5	37	79	
D06090	9,0	40	84	
D06095	9,5	40	84	
D06100	10,0	43	89	
D06102	10,2	43	89	
D06105	10,5	43	89	
D06110	11,0	47	95	
D06115	11,5	47	95	
D06120	12,0	51	102	
D06125	12,5	51	102	
D06130	13,0	51	102	
D06135	13,5	51	102	
D06140	14,0	54	107	
D06150	15,0	56	111	
D06160	16,0	58	115	
D06170	17,0	58	123	
D06180	18,0	62	123	
D06190	19,0	64	131	
D06200	20,0	66	131	



KARBÜR MATKAP UCU - STANDART BOY DIN/338

EKSTRA KALİTE KARBÜR MATKAP UCU

DIN 338 STANDART BOY

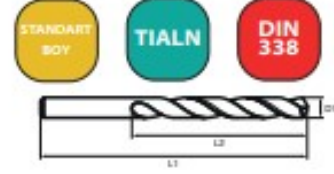

DECO KARBÜR MATKAP UCU - STANDART TİP

ÜRÜN KODU	ÖLÇÜ MM	KESİCİ BOY MM	TAM BOY MM	FİYAT USD
D05020	2	24	49	
D05025	2,5	30	57	
D05030	3	33	61	
D05032	3,2	33	65	
D05035	3,5	39	70	
D05040	4	43	75	
D05042	4,2	43	75	
D05045	4,5	47	80	
D05050	5	52	86	
D05052	5,2	52	90	
D05055	5,5	57	93	
D05060	6	57	93	
D05062	6,2	63	101	
D05065	6,5	63	101	
D05068	6,8	69	109	
D05070	7	69	109	
D05075	7,5	69	109	
D05080	8	75	117	
D05085	8,5	75	117	
D05090	9	81	125	
D05095	9,5	81	125	
D05100	10	87	133	
D05102	10,2	87	133	
D05105	10,5	87	133	
D05110	11	94	142	
D05115	11,5	94	142	
D05120	12	101	151	
D05125	12,5	101	151	
D05130	13	110	160	
D05135	13,5	101	165	
D05140	14	110	165	
D05150	15	114	170	
D05160	16	120	178	
D05170	17	125	184	
D05180	18	130	191	
D05190	19	135	200	
D05200	20	140	200	



PUNTA ÇÜRÜTME MATKABI



PUNTA ÇÜRÜTME - HSS

ÜRÜN KODU	AÇIKLAMA	FİYAT USD
D788981	6.0X66 MM	
D788982	7.0 X 74 MM	
D788983	8.0 X 74 MM	
D788984	10.0 X89 MM	

PUNTA ZIMBASI

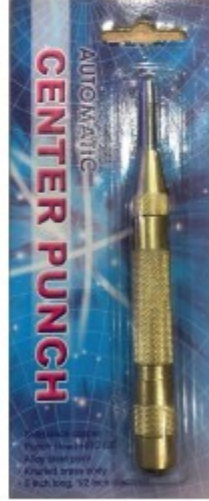

L = 120 MM

- Noktayı belirlemede en iyi sonuca ulařtırır.
- Yayından aldığı kuvvetle kolaylıkla işaretleme sağlar.
- Ayrıca acil durumlar için cam kırmaktada kullanılabilir.

ÜRÜN KODU

PUNTA ZIMBASI

FİYAT USD

CP-01

uzunluk : 120 mm

DIN/345 KONİK SAPLI MATKAP UCU



DECO DIN345 KONİK SAPLI MATKAP UCU

Ürün Kodu	Matkap Çapı (e)	Kesici Boyu	Tam Boyu	Konik Morsu	Fiyat USD
E47060	6	75	156	1	
E47065	6,5	75	156	1	
E47070	7	75	156	1	
E47075	7,5	75	156	1	
E47080	8	75	156	1	
E47085	8,5	75	156	1	
E47090	9	81	162	1	
E47095	9,5	81	162	1	
E47100	10	87	168	1	
E47105	10,5	87	168	1	
E47110	11	94	175	1	
E47115	11,5	94	175	1	
E47120	12	101	182	1	
E47125	12,5	101	182	1	
E47130	13	101	182	1	
E47135	13,5	108	189	1	
E47140	14	108	189	1	
E47145	14,5	114	212	2	
E47150	15	114	212	2	
E47155	15,5	120	218	2	
E47160	16	120	218	2	
E47165	16,5	125	223	2	
E47170	17	125	223	2	
E47175	17,5	130	228	2	
E47180	18	130	228	2	
E47185	18,5	135	233	2	
E47190	19	135	233	2	
E47195	19,5	140	238	2	
E47200	20	140	238	2	
E47205	20,5	146	243	2	

DECO DIN345 KONİK SAPLI MATKAP UCU

Ürün Kodu	Matkap Çapı (e)	Kesici Boyu	Tam Boyu	Konik Morsu	Fiyat USD
E47210	21	145	243	2	
E47215	21,5	150	248	2	
E47220	22	150	248	2	
E47225	22,5	155	253	2	
E47230	23	155	253	2	
E47235	23,5	155	276	3	
E47240	24	155	281	3	
E47245	24,5	160	281	3	
E47250	25	160	281	3	
E47255	25,5	165	286	3	
E47260	26	165	286	3	
E47265	26,5	165	286	3	
E47270	27	170	291	3	
E47275	27,5	170	291	3	
E47280	28	170	191	3	
E47285	28,5	175	296	3	
E47290	29	175	296	3	
E47295	29,5	175	296	3	
E47300	30	175	296	3	
E47305	30,5	180	301	3	
E47310	31	180	301	3	
E47315	31,5	180	301	3	
E47320	32	185	334	4	
E47325	32,5	185	334	4	
E47330	33	185	334	4	
E47335	33,5	185	334	4	
E47340	34	190	339	4	
E47345	34,5	190	339	4	
E47350	35	190	339	4	
E47355	35,5	190	339	4	



DECO DIN345 KONİK SAPLI MATKAP UCU

Ürün Kodu	Matkap Çapı (e)	Kesici Boyu	Tam Boyu	Konik Morsu	Fiyat USD
E47360	36	195	344	4	
E47365	36,5	195	344	4	
E47370	37	195	344	4	
E47375	37,5	195	344	4	
E47380	38	200	349	4	
E47385	38,5	200	349	4	
E47390	39	200	349	4	
E47395	39,5	200	349	4	
E47400	40	200	349	4	
E47405	40,5	205	354	4	
E47410	41	205	354	4	
E47415	41,5	205	354	4	
E47420	42	205	354	4	
E47425	42,5	205	354	4	
E47430	43	210	359	4	
E47435	43,5	210	359	4	
E47440	44	210	359	4	
E47445	44,5	210	359	4	
E47450	45	210	359	4	
E47455	45,5	215	364	4	
E47460	46	215	364	4	
E47465	46,5	215	364	4	
E47470	47	215	364	4	
E47475	47,5	215	364	4	
E47480	48	220	369	4	
E47485	48,5	220	369	4	
E47490	49	220	369	4	
E47495	49,5	220	369	4	
E47500	50	220	369	4	
E47510	51	225	412	5	

DECO DIN345 KONİK SAPLI MATKAP UCU

Ürün Kodu	Matkap Çapı (e)	Kesici Boyu	Tam Boyu	Konik Morsu	Fiyat USD
E47520	52	225	412	5	
E47530	53	230	412	5	
E47540	54	230	417	5	
E47550	55	230	417	5	
E47560	56	235	417	5	
E47570	57	235	422	5	
E47580	58	235	422	5	
E47590	59	235	422	5	
E47600	60	240	422	5	
E47610	61	240	427	5	
E47620	62	240	427	5	
E47630	63	245	427	5	
E47640	64	245	432	5	
E47650	65	245	432	5	
E47660	66	245	432	5	
E47670	67	245	432	5	
E47680	68	250	437	5	
E47690	69	250	437	5	
E47700	70	250	437	5	
E47710	71	250	437	5	
E47720	72	255	442	5	
E47730	73	255	442	5	
E47740	74	255	442	5	
E47750	75	255	442	5	
E47760	76	260	447	5	
E47770	77	260	514	5	
E47780	78	260	514	5	
E47790	79	260	514	5	
E47800	80	260	514	5	

DIN/345 KOBALTLI KONİK SAPLI MATKAP UCU

BEYAZ
KOMPLE
TAĞLAMASIZ

STANDART
BOY

CO
%5

DIN
345

KOBALTLI

DECO DIN345 KOBALTLI KONİK SAPLI MATKAP UCU

Ürün Kodu	Matkap Çapı (ø)	Kesici Boyu	Tam Boyu	Konik Morsu	Fiyat USD
D32014	14	108	189	1	
D32015	15	114	212	2	
D32016	16	120	218	2	
D32017	17	125	223	2	
D32175	17,5	130	228	2	
D32018	18	130	228	2	
D32019	19	135	233	2	
D32020	20	140	238	2	
D32021	21	145	243	2	
D32022	22	150	248	2	
D32225	22,5	155	253	2	
D32023	23	155	253	2	
D32024	24	155	281	3	
D32025	25	160	281	3	
D32026	26	165	286	3	
D32027	27	170	291	3	
D32028	28	170	191	3	
D32029	29	175	296	3	
D32030	30	175	296	3	
D32032	32	185	334	4	
D32033	33	185	334	4	
D32034	34	190	339	4	
D32035	35	190	339	4	
D32036	36	195	344	4	
D32037	37	195	344	4	
D32038	38	200	349	4	
D32039	39	200	349	4	
D32040	40	200	349	4	
D32042	42	205	354	4	
D32045	45	210	359	4	
D32050	50	220	369	4	



DIN/341 KONİK SAPLI UZUN BOY MATKAP UCU

BİYAZ
KOMPLE
TAĞLAMASIZ

UZUN
BOY

HSS

DIN
341

UZUN BOY

DECO DIN341 KONİK SAPLI UZUN BOY MATKAP UCU

Ürün Kodu	Matkap Çapı (ø)	Kesici Boyu	Tam Boyu	Fiyat USD
D33140	14	142	223	
D33150	15	147	245	
D33160	16	153	251	
D33170	17	159	257	
D33175	17,5	165	263	
D33180	18	165	263	
D33190	19	171	269	
D33200	20	177	275	
D33210	21	184	282	
D33220	22	191	289	
D33230	23	198	296	
D33240	24	206	327	
D33250	25	206	327	
D33260	26	214	335	
D33270	27	222	343	
D33280	28	222	343	
D33290	29	230	351	
D33300	30	230	351	
D33320	32	248	397	
D33350	35	257	406	
D33380	38	277	426	
D33400	40	277	426	
D33420	42	287	436	
D33450	45	298	447	
D33500	50	321	470	



DIN/1870 EKSTRA UZUN BOY KONİK SAPLI MATKAP UCU

BİNAZ
KOMPLE
TAĞLAŞIP

EKSTRA
UZUN
BOY

HSS

DIN
341

EKSTRA UZUN BOY

DECO DIN1870 EKSTRA UZUN KONİK SAPLI MATKAP UCU

Ürün Kodu	Matkap Çapı (ø)	Kesici Boyu	Tam Boyu	Fiyat USD
D34140	14	220	325	
D34150	15	220	340	
D34160	16	230	355	
D34170	17	230	355	
D34175	17,5	245	370	
D34180	18	245	370	
D34190	19	245	370	
D34200	20	260	385	
D34210	21	260	385	
D34220	22	270	405	
D34230	23	270	405	
D34240	24	290	440	
D34250	25	290	440	
D34260	26	290	440	
D34270	27	305	460	
D34280	28	305	460	
D34290	29	305	460	
D34300	30	305	460	
D34320	32	320	505	
D34350	35	340	530	
D34380	38	360	555	
D34400	40	360	555	
D34420	42	360	555	
D34450	45	385	585	
D34500	50	405	605	



DIN/333A PUNTA MATKABI



HSS

DIN
333A

DECO PUNTA MATKABI				
Ürün Kodu	Ölçü (mm)	Göbek Çapı	Tam Boyu	Fiyat USD
D01100	1,00MM	3,15	31,5	
D01125	1,25 MM	3,15	31,5	
D01160	1,60MM	4	35,5	
D01200	2,00 MM	5	40,0	
D01250	2,50 MM	6,3	45,0	
D01315	3,15 MM	8	50,0	
D01400	4,00 MM	10	56,0	
D01500	5,00MM	12,5	63,0	
D01630	6,3 MM	16	71,0	
D01800	8,00 MM	20	80,0	
D01900	10,0MM	25	100,0	



DECO UZUN BOY PUNTA MATKABI				
Ürün Kodu	Ölçü (mm)	Göbek Çapı (mm)	Tam Boyu (mm)	Fiyat USD
D02200	2,00MM	5	76	
D02250	2,50MM	6,3	102	
D02315	3,15 MM	8	102	
D02400	4,00MM	10	127	
D02500	5,00 MM	12,5	127	
D02630	6,3 MM	16	127	

DIN/334 60° HAVŞA FREZELERİ

60°

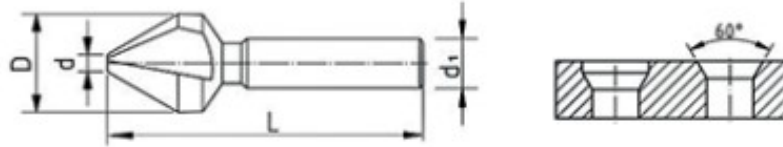

HSS

DIN 334

FERRE 60° HAVŞA FREZE - 60 DERECE HAVŞA FREZE

ÜRÜN KODU	D	L	d	d ₁	Fiyat Euro
F7960063	6,3	45	1,6	5	
F7960080	8	50	2	6	
F7960104	10,4	50	2,5	6	
F7960125	12,5	56	3,2	8	
F7960165	16,5	63	4	10	
F7960205	20,5	67	5	10	
F7960250	25	71	6,3	10	
F7960300	30	76	10	12	
F7960400	40	88	12,5	15	

DIN/334 60° HAVŞA FREZELERİ



Alton 90° Havşa Freze - HSS				
Ürün Kodu	D	d	L	Ürün Fiyatı USD
AH90083	8,3	6	50	
AH90104	10,4	6	50	
AH90124	12,4	8	56	
AH90160	16	8	60	
AH90165	16,5	10	60	
AH90200	20	10	63	
AH90205	20,5	10	63	
AH90250	25	10	66	
AH90255	25,5	10	67	
AH90300	30	12	71	
AH90315	31,5	12	71	
AH90350	35	12	80	
AH90400	40	13	80	
AH90500	50	13	85	

90° HAVŞA FREZE VE 60° HAVŞA FREZE

HSS

DECO 90° HAVŞA FREZE - 90 DERECE HAVŞA FREZE

ÜRÜN KODU	D	L	d	Fiyat USD
D0801	4,3	4	40	
D0802	5,3	5	40	
D0803	6	6	45	
D0804	8	6	50	
D0805	10	8	50	
D0806	12	10	56	
D0807	16	10	60	
D0808	16,5	10	60	
D0809	20,5	10	63	
D0810	25	10	67	
D0811	28	12	71	
D0812	30	10	71	
D0813	35	12	80	
D0814	40	12	80	
D0815	50	12	95	



HSS

DIN 334

60°

ALTON 60° HAVŞA FREZE - 60 DERECE HAVŞA FREZE

ÜRÜN KODU	D	L	d	d ₁	Fiyat USD
D0824	6,3	45	1,6	5	
D0825	8	50	2	6	
D0826	10	50	2,5	6	
D0827	12,5	56	3,2	8	
D0828	16,5	63	4	10	
D0829	20,5	67	5	10	
D0830	25	71	6,3	10	
D0831	30	76	10	12	
D0832	40	88	12,5	15	



90° KARBÜR HAVŞA FREZE ve KARBÜR PUNTA MATKABI



DECO 90° KARBÜR HAVŞA FREZE

Ürün Kodu	Ölçü D (ø)	Sap Çapı d (mm)	Tam Boyu L (mm)	Fiyat USD
KH1106	6	5	45	
KH1108	8	6	46/50	
KH1110	10	5	46/50	
KH1112	12	8	46/54	
KH1116	16	8	46,5/60	
KH1120	20	10	47/63	
KH1125	25	10	51/66	
KH1130	30	12	71	
KH1140	40	13	80	



KARBÜR PUNTA MATKABI

Ürün Kodu	Ölçü (mm)	Göbek Çapı	Fiyat USD
DK01200	2.0 MM	Q5 mm	
DK01250	2,5 MM	Q5 mm	
DK01315	3.15 MM	Q8 mm	
DK01400	4.0 MM	Q10 mm	
DK01500	5.0 MM	Q12,5 mm	

90° KONİK HAVŞA FREZE DIN/335



HSS



DIN 335

ALTON Konik 90° Havşa Freze

ÜRÜN KODU	D	L	d	HSS FİYAT USD
D0816	30,0	4,2	112	
D0817	34,0	4,5	118	
D0818	40,0	10	140	
D0819	45,0	12	145	
D0820	50,0	14	150	
D0821	63,0	16	155	
D0822	80,0	22	165	
D0823D	100,0	30	200	

NAREX BUCOVICE HAVŞA FREZE - 90 DERECE

NAREX
BUCOVICE
ÇEKYA



HSS

NAREX 90° HAVŞA FREZE - 90 DERECE HAVŞA FREZE				
ÜRÜN KODU	D	d	L	Fiyat EURO
H11080	8	6	46/50	
H11010	10	6	46/50	
H11115	11,5	8	56	
H11120	12	8	46/54	
H11124	12,4	8	54	
H11160	16	8	46,5/60	
H11165	16,5	10	60	
H11200	20	10	47/63	
H11205	20,5	10	63	
H11230	23	10	67	
H11250	25	10	51/66	
H11255	25,5	10	66	
H11300	30	10	71	
H11315	31,5	12	80	
H11350	35	12	80	
H11400	40	13	85	
H11500	50	13	85	

NAREX BUCOVICE TİN KAPLI HAVŞA FREZE - 90 DERECE

NAREX
BUCOVICE
ÇEKYA

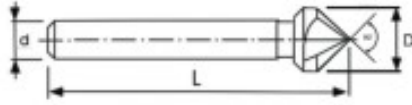

NAREX 90° TİN KAPLI HAVŞA FREZE

ÜRÜN KODU	D	d	L	Fiyat EURO
TH11080	8	6	46/50	
TH11010	10	6	46/50	
TH11115	11,5	8	56	
TH11120	12	8	46/54	
TH11124	12,4	8	54	
TH11160	16	8	46,5/60	
TH11165	16,5	10	60	
TH11200	20	10	47/63	
TH11205	20,5	10	63	
TH11230	23	10	67	
TH11250	25	10	51/66	
TH11255	25,5	10	66	
TH11300	30	10	71	
TH11315	31,5	12	80	
TH11350	35	12	80	
TH11400	40	13	85	
TH11500	50	13	85	

NAREX BUCOVICE VA SERİSİ KOBALTLI HAVŞA FREZE DIN/335C

NAREX
BUCOVICE
ÇEKYA



DIN 335 C



PASLANMAZ İÇİNDİR

SÜPER YÜKSEK HIZ ÇELİĞİ



- Havşalama işlemlerinde kullanılır.
- Delme işlemlerinde kullanılır.
- Paslanmaz malzemeler için kullanılır.
- Demir ve demir dışı metallerde kullanılır.

CO
%5

NAREX 90° VA SERİSİ KOBALTLI HAVŞA FREZE

ÜRÜN KODU	D	d	L	Fiyat EURO
H4201	6,3	5	45	
H4202	8	6	50	
H4203	10	6	50	
H4204	12,4	8	56	
H4205	16,5	10	60	
H4206	20,5	10	63	
H4207	25	10	68	
H4208	30	12	71	
H4209	40	12	80	

NAREX BUCOVICE HAVŞA AÇMA UCU - BİTS

NAREX
BUČOVICE
ÇEKYA

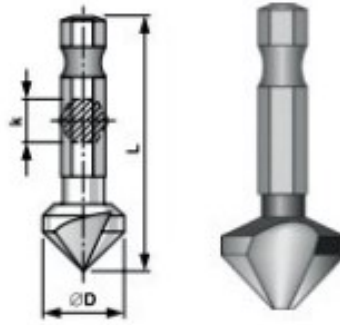

NAREX HAVŞA AÇMA UCU - BİTS				
ÜRÜN KODU	D	L	K	Fiyat EURO
N0301	6,3	37	1/4	
N0302	8,3	39	1/4	
N0303	10,4	40	1/4	
N0304	12,4	42	1/4	
N0305	16,5	45	1/4	
N0306	20,5	49	1/4	

NAREX BUÇOVİCE ÇOK AĞIZLI HAVŞA FREZE DIN/335

NAREX
BUÇOVİCE
ÇEKYA

DIN 335



HSS

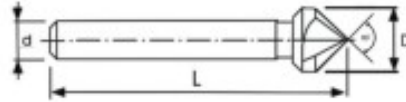

NAREX ÇOK AĞIZLI HAVŞA FREZE

ÜRÜN KODU	D	d	L	Fiyat EURO
H4301	8	8	48	
H4302	12,5	8	48	
H4303	16	10	56	
H4304	20	10	60	
H4305	25	10	67	

SABİT PİLOTLU HAVŞA FREZE - DELİKLİ HAVŞA FREZE

NAREX
BUČOVICE
ÇEKYA



NAREX SABİT PİLOTLU HAVŞA FREZE									
ÜRÜN KODU	CİVATA	D z9	d ₁ e8	d ₂ h9	L	l	l ₁	l ₂	Fiyat EURO
H1202	M2	4	2,2	4,3	56	3	10	31,5	
H1203	M3	6	3,2	5	71	3,2	14	31,5	
H1204	M4	8	4,3	5	71	4,3	14	31,5	
H1205	M5	10	5,3	8	80	5,3	18	35,5	
H1206	M6	11	6,4	8	80	6,4	18	35,5	
H1208	M8	15	8,4	12,5	100	8,4	22	40	
H1210	M10	18	10,5	12,5	100	10,5	22	40	
H1212	M12	20	13	12,5	100	13	22	40	



NAREX DELİKLİ HAVŞA FREZE - ZENKER					
ÜRÜN KODU	D	DMM	dmm	LMM	Fiyat EURO
H1305	2/5	10	6	46	
H1310	5/10	14	8	46	
H1315	10/15	21,5	10	64,5	
H1320	15/20	28	12	80	
H1321	20/25	35	15	97	
H1330	25/30	44	15	115	

SABİT PİLOTLU HAVŞA FREZE (SENKER)

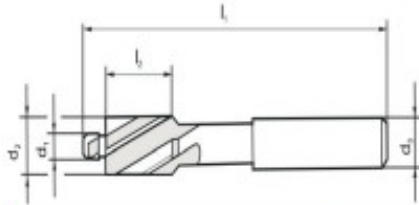

HSS

DIN
373

SABİT PİLOTLU HAVŞA FREZE

Ürün Kodu	Civata	d ₂ (mm)	d ₁ (mm)	d ₃ (mm)	l ₁ (mm)	l ₂ (mm)	Fiyat USD
CHT03	M3	6	3,2	5	71	14	
CHT04	M4	8	4,3	5	71	14	
CHT05	M5	10	5,3	8	80	18	
CHT06	M6	11	6,4	8	80	18	
CHT08	M8	15	8,4	12,5	100	22	
CHT10	M10	18	10,5	12,5	100	22	
CHT12	M12	20	13	12,5	100	22	
CHT14	M14	24	15	12,5	100	22	
CHT16	M16	26	17	12,5	100	22	

KADEMELİ SAÇ DELME MATKABI VE SETİ

TİAIN KAPLAMALI
EKSTRA BİRİNCİ KALİTE



TİAIN KAPLAMALI KADEMELİ SAÇ DELME MATKABI

ÜRÜN KODU	EBAT	ÖLÇÜLER	Fiyat USD
CMK420	4-20	4-6-8-10-12-14-16-18-20	
CMK535	5-35	5-8-10-12-15-18-20-22-25-27-30-32-35	
CMK439	4-39	4-6-9-12-15-18-21-24-27-30-33-36-39	
CMK652	6-52	6-12-16-20-24-28-32-36-40-44-48-52	



KADEMELİ SAÇ DELME MATKABI SETİ

ÜRÜN KODU	SET İÇERİĞİ	Fiyat USD
CMKSET	4-12 / 4-20 / 4-32	

TAM TAKIM APARAT MAKİNA
SAN. VE TİC. LTD. ŞTİ.
www.tamtakim.com

KADEMELİ SAÇ DELME MATKABI VE SETİ



ALTON KADEMELİ MATKAP UCU

Ürün Kodu	Matkap Aralığı	Fiyat USD
ACMK412	4-12	
ACMK420	4-20	
ACMK430	4-30	
ACMK432	4-32	
ACMK439	4-39	
ACMK535	5-35	
ACMK652	6-52	



ALTON KADEMELİ SAÇ DELME MATKABI SETİ

ÜRÜN KODU	SET İÇERİĞİ	Fiyat USD
ACMKSET	4-12 / 4-20 / 4-32	